

TSYS02P Digital Temperature Sensor

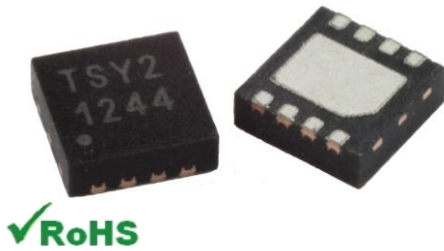

- High Accuracy Temperature Sensor
- 16 bit Resolution
- High Speed, low Response Time
- Low Power Consumption
- PWM Output
- Small TDFN8 Package

DESCRIPTION

The TSYS02P is a single chip, temperature sensor.

It provides factory calibrated data corresponding to the measured temperature.

The data is provided via **PWM output**.

The temperature range is -40°C ... $+125^{\circ}\text{C}$ while the resolution is 0.01°C .

The TDFN8 package provides smallest size and very fast time response.

FEATURES

High Accuracy $\pm 0.2^{\circ}\text{C}$ @ Temp.: -5°C ... $+50^{\circ}\text{C}$
 Adjustment of high accuracy temperature range on request
 Low Supply Current $< 420\mu\text{A}$ (standby $< 0.14\mu\text{A}$)
 PWM Output
 Small IC-Package TDFN8 2.5mm x 2.5mm
 Operating Temperature Range: -40°C ... $+125^{\circ}\text{C}$

APPLICATIONS

Industrial Control
 Replacement of Precision RTDs,
 Thermistors and NTCs
 Heating / Cooling Systems
 HVAC

TSYS02P Digital Temperature Sensor

ABSOLUTE MAXIMUM RATINGS

Absolute maximum ratings are limiting values of permitted operation and should never be exceeded under the worst possible conditions either initially or consequently. If exceeded by even the smallest amount, instantaneous catastrophic failure can occur. And even if the device continues to operate satisfactorily, its life may be considerably shortened.

Parameter	Symbol	Conditions	Min	Typ	Max	Unit
Supply Voltage	VDD		-0.3		+3.6	V
Operating Temperature	Top		-40		+125	°C
Storage temperature	Tstor		-55		+150	°C
ESD rating	ESD	Human Body Model (HBM) pin to pin incl. VDD & GND	-2		+2	kV
Humidity	Hum		Non condensing			

OPERATING CONDITIONS

Parameter	Symbol	Conditions	Min	Typ	Max	Unit
Operating Supply Voltage	V _{DD}	stabilized	1.5		3.6	V
Supply Current	I _{DD}	2 sample per second		36		μA
Peak Supply Current	I _{DD}	During conversion		420		μA
Conversion Time	T _{CONV}			43		ms
Measurement Frequency	F _{MEAS}			2		Hz
PWM Period	T _{PERIOD}		7.5	8.3	9.1	ms
VDD Capacitor		Place close to the chip	100nF			

OPERATIONAL CHARACTERISTICS

If not otherwise noted, 3.3V supply voltage is applied.

Parameter	Symbol	Conditions	Min	Typ	Max	Unit
Temp. Measurement Range	T _{RANG}		-40		125	°C
Accuracy 1	T _{ACC1}	-5°C < T < +50°C V _{DD} = 3.2V – 3.4V	-0.2		+0.2	°C
Accuracy 2	T _{ACC2}	-20°C < T < +100°C V _{DD} = 3.2V – 3.4V	-0.5		+0.5	°C
Accuracy 3	T _{ACC2}	-40°C < T < +125°C V _{DD} = 3.2V – 3.4V	-1.0		+1.0	°C
PSRR Power Supply Reject Ratio		V _{DD} = 2.7 – 3.6 T = 25°C, C = 100nF			0.1	°C
Temperature Resolution	T _{RES}				0.01	°C
Self Heating	SH ₁	10 samples/s, 60s, still air			0.1	°C

TSYS02P Digital Temperature Sensor

ACCURACY

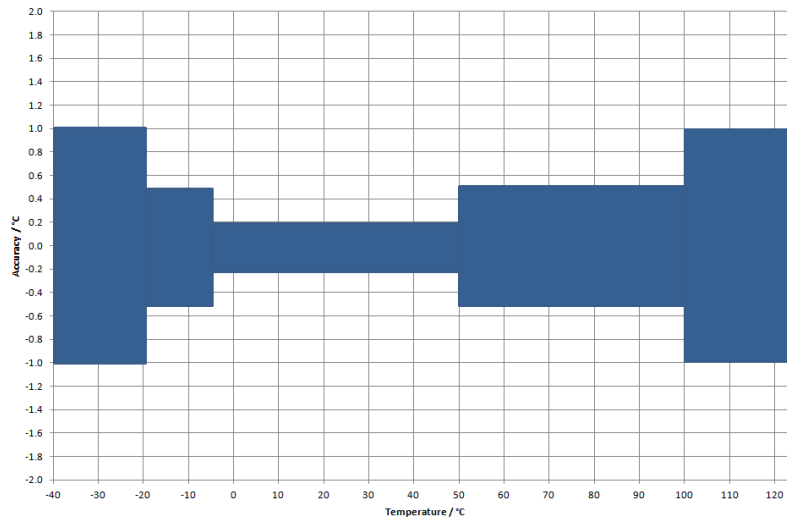

ANALOGUE TO DIGITAL CONVERTER

Parameter	Symbol	Conditions	Min	Typ	Max	Unit
Resolution				16		bit
Conversion Time	t_c			43		ms

DIGITAL OUTPUTS (PWM)

Parameter	Symbol	Conditions	Min	Typ	Max	Unit
Output High Voltage	VOH			VDD		V
Output Low Voltage	VOL			0		V
Output Sink Current	IOL				40	μA

TSYS02P Digital Temperature Sensor

CONNECTION DIAGRAM

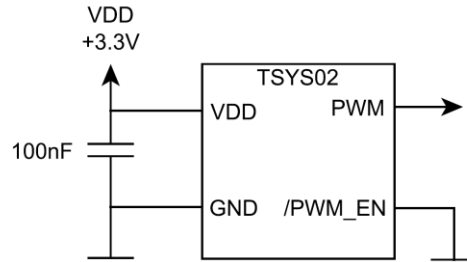

PIN FUNCTION TABLE

Pin	Name	Type	Function
1	VDD	Power	Supply Voltage
2	/PWM_EN	Digital Input	Enable PWM Output (0 = ON)
3	PWM	Digital Output	PWM Output
4	VSS	Power	Ground
5 – 8	NC	---	Not connected / Do not connect

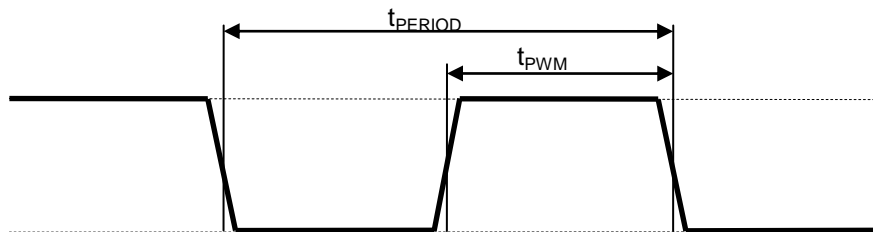

PWM OUTPUT

START UP

After power-up (VDD between 1.8V and 3.6V) TSYS02P needs at most 150ms for reaching idle state. During that time PWM output is in undefined state. Afterwards, TSYS02P starts measuring and provides data on PWM output.

TEMPERATURE CALCULATION

TEMPERATURE POLYNOMIAL

$$T / ^\circ\text{C} = t_{\text{PWM}} / t_{\text{PERIOD}} \times 175.72 - 46.85$$

EXAMPLE

$$t_{\text{PWM}}: 4.15\text{ms}$$

$$t_{\text{PERIOD}}: 8.30\text{ms}$$

TSYS02P Digital Temperature Sensor

$$T / ^\circ\text{C} = 4.15\text{ms} / 8.30\text{ms} \times 175.72 - 46.85$$

$$T / ^\circ\text{C} = \underline{41.01^\circ\text{C}}$$

TSYS02P Digital Temperature Sensor

DIMENSIONS

TOP VIEW

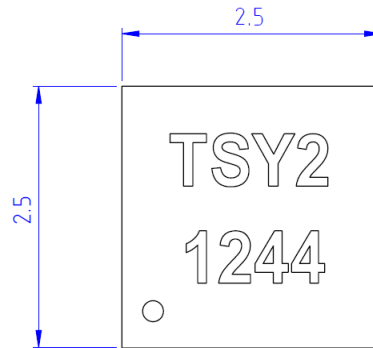

BOTTOM VIEW

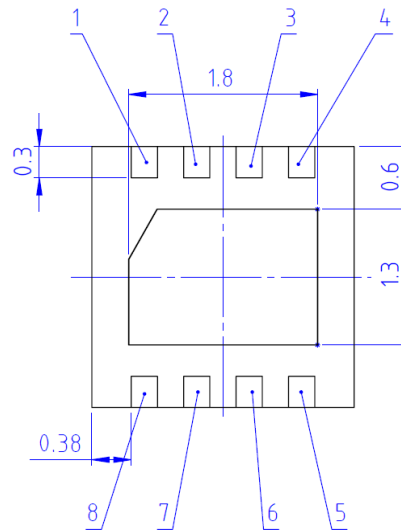

SIDE VIEW

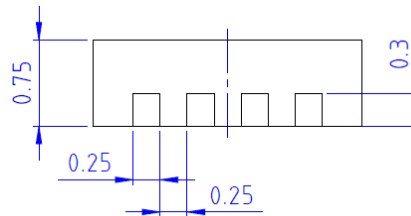

MARKING

Line	Description	Example
1	Product Name	TSY2
2	Pin 1 Dot, Date Code YYWW	1244

TSYS02P Digital Temperature Sensor

ORDER INFORMATION

The TSYS02 temperature sensor family comprises currently three different solutions. Further customer specific adaptations are available on request. Please refer to the table below for part name, description and order information.

Part Name	Description	Order Number
TSYS02D	Digital Temperature Sensor, TDFN8, I2C Interface	G-NIMO-003
TSYS02P	Digital Temperature Sensor, TDFN8, PWM Interface	G-NIMO-004
TSYS02S	Digital Temperature Sensor, TDFN8, SDM Interface	G-NIMO-005

EMC

Due to the use of these modules for OEM application no CE declaration is done. Especially line coupled disturbances like surge, burst, HF etc. cannot be removed by the module due to the small board area and low price feature. There is no protection circuit against reverse polarity or over voltage implemented. The module will be designed using capacitors for blocking and ground plane areas in order to prevent wireless coupled disturbances as good as possible.

DEFINITIONS AND DISCLAIMERS

- Application information – Applications that are described herein for any of these products are for illustrative purpose only. MEAS Deutschland GmbH makes no representation or warranty that such applications will be suitable for the specified use without further testing or modification.
- Life support applications – These products are not designed for use in life support appliances, devices, or systems where malfunctions of these products can reasonably be expected to result in personal injury. MEAS Deutschland GmbH customers using or selling this product for use in such applications do so at their own risk and agree to fully indemnify MEAS Deutschland GmbH for any damages resulting from such improper use or sale.

The information in this sheet has been carefully reviewed and is believed to be accurate; however, no responsibility is assumed for inaccuracies. Furthermore, this information does not convey to the purchaser of such devices any license under the patent rights to the manufacturer. Measurement Specialties, Inc. reserves the right to make changes without further notice to any product herein. Measurement Specialties, Inc. makes no warranty, representation or guarantee regarding the suitability of its product for any particular purpose, nor does Measurement Specialties, Inc. assume any liability arising out of the application or use of any product or circuit and specifically disclaims any and all liability, including without limitation consequential or incidental damages. Typical parameters can and do vary in different applications. All operating parameters must be validated for each customer application by customer's technical experts. Measurement Specialties, Inc. does not convey any license under its patent rights nor the rights of others.